



GAMM

Maniglie a ripresa

Adjustable clamping levers

Manijas ajustables



Descrizione

Bussola in ottone e foro cieco filettato.

Brass insert with tapped blind hole.
Inserto de latón y agujero ciego roscado.

Materiale

Tecnopolimero nero rinforzato con fibre di vetro, finitura opaca.

Black thermoplastic, glass fiber reinforced, mat.
Termoplástico negro reforzado con fibra de vidrio, acabado mate.

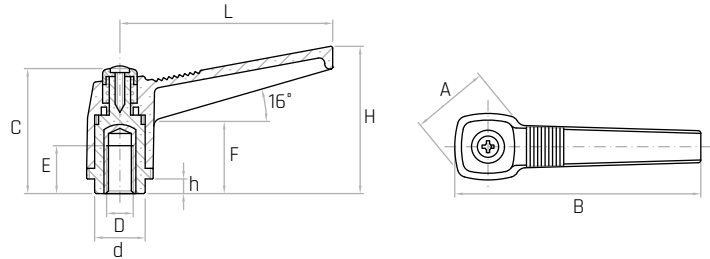

Codice	Modello	L mm	C mm	A mm	B mm	H mm	F mm	d mm	h mm	E mm	D	Peso gr.
6355005	KRB/42 M4	42	29	19	50	32	17	12	3	9	M4	11
6355010	KRB/42 M5	42	29	19	50	32	17	12	3	9	M5	11
6355015	KRB/42 M6	42	29	19	50	32	17	12	3	9	M6	11
6356010	KRB/63 M5	63	39	25	73	43	21	15	4	13	M5	23
6356015	KRB/63 M6	63	39	25	73	43	21	15	4	13	M6	23
6356020	KRB/63 M8	63	39	25	73	43	21	15	4	13	M8	24
6357010	KRB/80 M8	80	48	30	92	54	27	19	6	15	M8	44
6357015	KRB/80 M10	80	48	30	92	54	27	19	6	16	M10	44
6357020	KRB/80 M12	80	48	30	92	54	27	19	6	18	M12	45
6358010	KRB/100 M12	100	58	36	115	66	30	25	8	18	M12	83
6358015	KRB/100 M14	100	58	36	115	66	30	25	8	20	M14	84
6358020	KRB/100 M16	100	58	36	115	66	30	25	8	20	M16	87

NOTE: Arancione RAL 2004 colore standard disponibile a magazzino. Si forniscono, per quantità adeguate, in colori diversi e con inserti a misura.

Orange RAL 2004 available on stock. For certain minimum quantities, custom colors and tapped metal inserts available upon request.

Naranja RAL 2004 disponible en stock. Por cantidad apropiada, disponible también en colores diferentes y con insertos de distintas medidas.

Descrizione

Perno in acciaio zincato filettato.

Threaded zinc plated steel stud.

Perno de acero galvanizado roscado.

Materiale

Tecnopolimero nero rinforzato con fibre di vetro, finitura opaca.

Black thermoplastic, glass fiber reinforced, mat.

Termoplástico negro reforzado con fibra de vidrio, acabado mate.

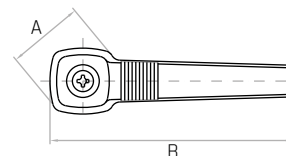
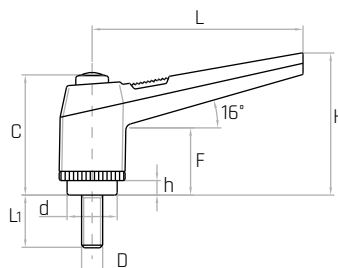

Codice	Modello	L mm	C mm	A mm	B mm	H mm	F mm	d mm	h mm	L1 mm	D	Peso gr.
6355610	KRP/42 M4x20	42	29	19	50	32	17	12	3	20	M4	11
6355620	KRP/42 M5x20	42	29	19	50	32	17	12	3	20	M5	13
6355630	KRP/42 M5x30	42	29	19	50	32	17	12	3	30	M5	14
6355635	KRP/42 M6x15	42	29	19	50	32	17	12	3	15	M6	14
6355640	KRP/42 M6x20	42	29	19	50	32	17	12	3	20	M6	15
6355650	KRP/42 M6x30	42	29	19	50	32	17	12	3	30	M6	16
6356610	KRP/63 M5x20	63	39	25	73	43	21	15	4	20	M5	24
6356615	KRP/63 M6x15	63	39	25	73	43	21	15	4	15	M6	26
6356620	KRP/63 M6x20	63	39	25	73	43	21	15	4	20	M6	28
6356625	KRP/63 M6x25	63	39	25	73	43	21	15	4	25	M6	29
6356630	KRP/63 M6x30	63	39	25	73	43	21	15	4	30	M6	30
6356640	KRP/63 M6x40	63	39	25	73	43	21	15	4	40	M6	31
6356650	KRP/63 M8x15	63	39	25	73	43	21	15	4	15	M8	32
6356665	KRP/63 M8x20	63	39	25	73	43	21	15	4	20	M8	33
6356670	KRP/63 M8x25	63	39	25	73	43	21	15	4	25	M8	34
6356675	KRP/63 M8x30	63	39	25	73	43	21	15	4	30	M8	36
6356680	KRP/63 M8x35	63	39	25	73	43	21	15	4	35	M8	37
6356685	KRP/63 M8x40	63	39	25	73	43	21	15	4	40	M8	38
6356695	KRP/63 M8x50	63	39	25	73	43	21	15	4	50	M8	39
6357610	KRP/80 M8x20	80	48	30	92	54	27	19	6	20	M8	48
6357620	KRP/80 M8x30	80	48	30	92	54	27	19	6	30	M8	51
6357625	KRP/80 M8x35	80	48	30	92	54	27	19	6	35	M8	53
6357630	KRP/80 M8x40	80	48	30	92	54	27	19	6	40	M8	55
6357640	KRP/80 M8x50	80	48	30	92	54	27	19	6	50	M8	58
6357650	KRP/80 M10x20	80	48	30	92	54	27	19	6	20	M10	55
6357665	KRP/80 M10x25	80	48	30	92	54	27	19	6	25	M10	58
6357670	KRP/80 M10x30	80	48	30	92	54	27	19	6	30	M10	61
6357680	KRP/80 M10x40	80	48	30	92	54	27	19	6	40	M10	66
6357690	KRP/80 M10x50	80	48	30	92	54	27	19	6	50	M10	71
6357700	KRP/80 M10x60	80	48	30	92	54	27	19	6	60	M10	78
6357720	KRP/80 M12x20	80	48	30	92	54	27	19	6	20	M12	75
6357730	KRP/80 M12x30	80	48	30	92	54	27	19	6	30	M12	82
6357740	KRP/80 M12x40	80	48	30	92	54	27	19	6	40	M12	88
6357750	KRP/80 M12x50	80	48	30	92	54	27	19	6	50	M12	95
6357760	KRP/80 M12x60	80	48	30	92	54	27	19	6	60	M12	102
6358620	KRP/100 M12x30	100	58	36	115	66	30	25	8	30	M12	114
6358630	KRP/100 M12x40	100	58	36	115	66	30	25	8	40	M12	120
6358640	KRP/100 M12x50	100	58	36	115	66	30	25	8	50	M12	126
6358650	KRP/100 M12x60	100	58	36	115	66	30	25	8	60	M12	138
6358660	KRP/100 M12x70	100	58	36	115	66	30	25	8	70	M12	149
6358680	KRP/100 M14x30	100	58	36	115	66	30	25	8	30	M14	142
6358690	KRP/100 M14x40	100	58	36	115	66	30	25	8	40	M14	146
6358700	KRP/100 M14x50	100	58	36	115	66	30	25	8	50	M14	162
6358710	KRP/100 M14x60	100	58	36	115	66	30	25	8	60	M14	170
6358720	KRP/100 M14x70	100	58	36	115	66	30	25	8	70	M14	181
6358740	KRP/100 M16x30	100	58	36	115	66	30	25	8	30	M16	157
6358750	KRP/100 M16x40	100	58	36	115	66	30	25	8	40	M16	170
6358760	KRP/100 M16x50	100	58	36	115	66	30	25	8	50	M16	184
6358770	KRP/100 M16x60	100	58	36	115	66	30	25	8	60	M16	198
6358780	KRP/100 M16x70	100	58	36	115	66	30	25	8	70	M16	210

NOTE: Arancione RAL 2004 colore standard disponibile a magazzino. Si forniscono, per quantità adeguate, in colori diversi e con inserti a misura.

Orange RAL 2004 available on stock. For certain minimum quantities, custom colors and threaded metal studs available upon request.

Naranja RAL 2004 disponible en stock. Por cantidad apropiada, disponible también en colores diferentes y con insertos de distintas medidas.

KRBX

Maniglia a ripresa
Adjustable clamping lever / Manija ajustable



Descrizione

Bussola in acciaio inox AISI 303 e foro cieco filettato.

Stainless steel insert with tapped blind hole (AISI 303).

Inserto de acero inoxidable y agujero ciego roscado (AISI 303).

Materiale

Tecnopolimero nero rinforzato con fibre di vetro, finitura opaca.

Black thermoplastic, glass fiber reinforced, mat.

Termoplástico negro reforzado con fibra de vidrio, acabado mate.

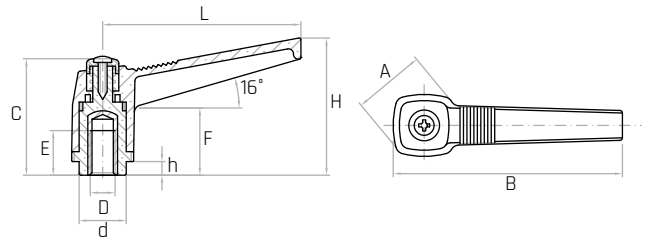

Codice	Modello	L mm	C mm	A mm	B mm	H mm	F mm	d mm	h mm	E mm	D	Peso gr.
6355800	KRBX/42 M6	42	29	19	50	32	17	12	3	9	M6	11
6356795	KRBX/63 M6	63	39	25	73	43	21	15	4	13	M6	23
6356800	KRBX/63 M8	63	39	25	73	43	21	15	4	13	M8	24
6357795	KRBX/80 M8	80	48	30	92	54	27	19	6	18	M8	44
6357800	KRBX/80 M10	80	48	30	92	54	27	19	6	18	M10	44

NOTE: Arancione RAL 2004 colore standard disponibile a magazzino. Si forniscono, per quantità adeguate, in colori diversi.

Orange RAL 2004 available on stock. For certain minimum quantities, custom colors available upon request.

Naranja RAL 2004 disponible en stock. Por cantidad apropiada, disponible también en colores diferentes.

KRPX

Maniglia a ripresa
Adjustable clamping lever / Manija ajustable



Descrizione

Perno in acciaio filettato inox AISI 303.

Threaded stainless steel stud (AISI 303).

Perno de acero inoxidable roscado (AISI 303).

Materiale

Tecnopolimero nero rinforzato con fibre di vetro, finitura opaca.

Black thermoplastic, glass fiber reinforced, mat.

Termoplástico negro reforzado con fibra de vidrio, acabado mate.

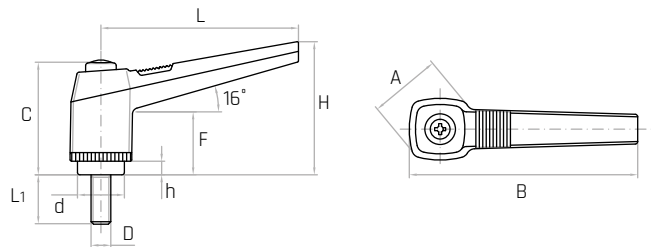

Codice	Modello	L mm	C mm	A mm	B mm	H mm	F mm	d mm	h mm	L1 mm	D	Peso gr.
6386000	KRPX/42 M6x20	42	29	19	50	32	17	12	3	20	M6	15
6386010	KRPX/42 M6x30	42	29	19	50	32	17	12	3	30	M6	16
6386020	KRPX/63 M8x20	63	39	25	73	43	21	15	4	20	M8	33
6386030	KRPX/63 M8x25	63	39	25	73	43	21	15	4	25	M8	34
6386040	KRPX/63 M8x30	63	39	25	73	43	21	15	4	30	M8	36
6386042	KRPX/63 M8x40	63	39	25	73	43	21	15	4	40	M8	39
6386043	KRPX/63 M8x50	63	39	25	73	43	21	15	4	50	M8	40
6386044	KRPX/80 M8x20	80	48	30	92	54	27	19	6	20	M8	49
6386045	KRPX/80 M8x30	80	48	30	92	54	27	19	6	30	M8	52
6386047	KRPX/80 M8x40	80	48	30	92	54	27	19	6	40	M8	56
6386049	KRPX/80 M8x50	80	48	30	92	54	27	19	6	50	M8	59
6386050	KRPX/80 M10x25	80	48	30	92	54	27	19	6	25	M10	58
6386060	KRPX/80 M10x30	80	48	30	92	54	27	19	6	30	M10	61
6386070	KRPX/80 M10x40	80	48	30	92	54	27	19	6	40	M10	66
6386080	KRPX/80 M10x50	80	48	30	92	54	27	19	6	50	M10	71

NOTE: Arancione RAL 2004 colore standard disponibile a magazzino. Si forniscono, per quantità adeguate, in colori diversi.

Orange RAL 2004 available on stock. For certain minimum quantities, custom colors available upon request.

Naranja RAL 2004 disponible en stock. Por cantidad apropiada, disponible también en colores diferentes.

KFB

Maniglia fissa Clamping lever / Manilla fija



Descrizione

Bussola in ottone e foro cieco filettato.
Brass insert with tapped blind hole.
Inserto de latón y agujero ciego roscado.

Materiale

Tecnopolimero nero rinforzato con fibre di vetro, finitura opaca.
Black thermoplastic, glass fiber reinforced, mat.
Termoplástico negro reforzado con fibra de vidrio, acabado mate.

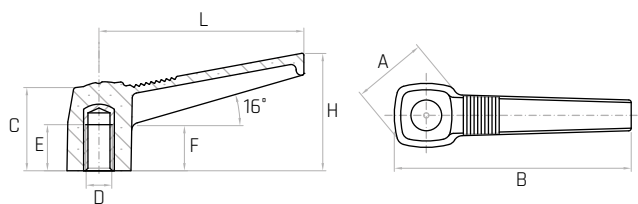

Codice	Modello	L mm	C mm	A mm	B mm	H mm	F mm	E mm	D	Peso gr.
6351010	KFB/42 M5	42	20	19	50	25	11	9	M5	8
6351015	KFB/42 M6	42	20	19	50	25	11	9	M6	8
6352020	KFB/63 M6	63	26	25	73	35	14	13	M6	20
6352025	KFB/63 M8	63	26	25	73	35	14	13	M8	20
6353010	KFB/80 M8	80	33	30	92	45	17	15	M8	37
6353015	KFB/80 M10	80	33	30	92	45	17	16	M10	38
6353020	KFB/80 M12	80	33	30	92	45	17	18	M12	39
6354010	KFB/100 M12	100	39	36	115	55	18	18	M12	68
6354015	KFB/100 M14	100	39	36	115	55	18	20	M14	72
6354020	KFB/100 M16	100	39	36	115	55	18	20	M16	76

NOTE: Si forniscono, per quantità adeguate, in colori diversi e con inserti a misura.
For certain minimum quantities, custom colors and tapped metal inserts available upon request.
Por cantidad apropiada, disponible también en colores diferentes y con insertos de distintas medidas.

KFP

Maniglia fissa Clamping lever / Manilla fija



Descrizione

Perno in acciaio zincato filettato.
Threaded zinc plated steel stud.
Perno de acero galvanizado roscado.

Materiale

Tecnopolimero nero rinforzato con fibre di vetro, finitura opaca.
Black thermoplastic, glass fiber reinforced, mat.
Termoplástico negro reforzado con fibra de vidrio, acabado mate.

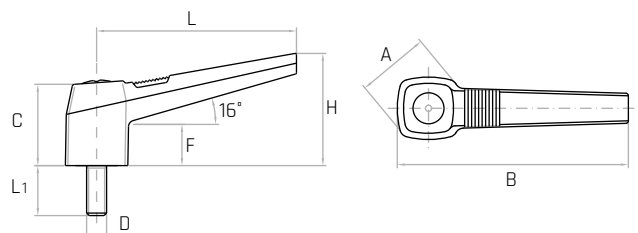

Codice	Modello	L mm	C mm	A mm	B mm	H mm	F mm	L1 mm	D	Peso gr.
6351400	KFP/42 M6x15	42	20	19	50	25	11	15	M6	11
6351405	KFP/42 M6x20	42	20	19	50	25	11	20	M6	12
6352400	KFP/63 M8x25	63	26	25	73	35	14	25	M8	30
6353350	KFP/80 M8x20	80	33	30	92	45	17	20	M8	52
6353400	KFP/80 M10x30	80	33	30	92	45	17	30	M10	57
6354400	KFP/100 M12x50	100	39	36	115	55	18	50	M12	121

NOTE: Si forniscono, per quantità adeguate, in colori diversi e con inserti a misura.
For certain minimum quantities, custom colors and threaded metal studs available upon request.
Por cantidad apropiada, disponible también en colores diferentes y con insertos de distintas medidas.

Descrizione

Bussola in ottone e foro cieco filettato.

Brass insert with tapped blind hole.
Inserto de latón y agujero ciego roscado.

Materiale

Tecnopolimero nero rinforzato con fibre di vetro, finitura opaca.

Black thermoplastic, glass fiber reinforced, mat.
Termoplástico negro reforzado con fibra de vidrio, acabado mate.

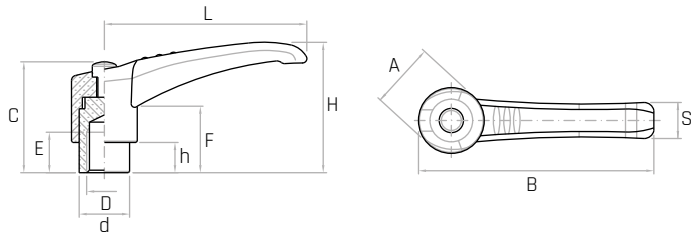

Codice	Modello	L mm	C mm	A mm	B mm	S mm	H mm	F mm	d mm	h mm	E mm	D	Peso gr.
7342005	LRB/45 M5	45	29	16	53	10,5	33,5	18	12	7,5	8	M5	22
7342010	LRB/45 M6	45	29	16	53	10,5	33,5	18	12	7,5	8	M6	24
7342015	LRB/65 M6	65	34	20	75	13,5	41	19	15	7,5	11	M6	26
7342020	LRB/65 M8	65	34	20	75	13,5	41	19	15	7,5	11	M8	24
7342025	LRB/80 M8	80	44	24	92	16,5	53	26	20	12	16	M8	55
7342030	LRB/80 M10	80	44	24	92	16,5	53	26	20	12	16	M10	56
7342035	LRB/80 M12	80	44	24	92	16,5	53	26	20	12	16	M12	57
7342050	LRB/95 M12	95	50	27	108	19	61	30	21	13	22	M12	83
7342055	LRB/95 M14	95	50	27	108	19	61	30	21	13	22	M14	94
7342060	LRB/95 M16	95	50	27	108	19	61	30	21	13	22	M16	89

NOTE: Su richiesta è disponibile il pulsante nei colori: arancione RAL 2004, rosso RAL 3020, giallo RAL 1021, blu RAL 5015, verde RAL 6018 e grigio RAL 7035. Si forniscono, per quantità adeguate, in colori diversi e con inserti a misura.

On request, the button is available in orange RAL 2004, red RAL 3020, yellow RAL 1021, blue RAL 5015, green RAL 6018 and grey RAL 7035. For certain minimum quantities, custom colors and tapped metal inserts available upon request.

A petición, el pulsador está disponible en los siguientes colores: naranja RAL 2004, rojo RAL 3020, amarillo RAL 1021, azul RAL 5015, verde RAL 6018 y gris RAL 7035. Por cantidad apropiada, disponible también en colores diferentes y con insertos de distintas medidas.

Descrizione

Perno in acciaio zincato filettato.

Threaded zinc plated steel stud.

Perno de acero galvanizado roscado.



Materiale

Tecnopolimero nero rinforzato con fibre di vetro, finitura opaca.

Black thermoplastic, glass fiber reinforced, mat.

Termoplástico negro reforzado con fibra de vidrio, acabado mate.

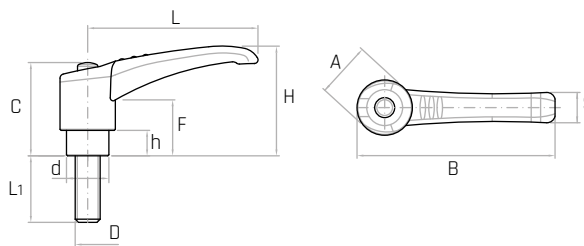

Codice	Modello	L mm	B mm	A mm	S mm	H mm	C mm	F mm	d mm	h mm	L1 mm	D	Peso gr.
7343005	LRP/45 M5x20	45	53	16	10,5	33,5	29	18	12	7,5	20	M5	19
7343010	LRP/45 M5x30	45	53	16	10,5	33,5	29	18	12	7,5	30	M5	20
7343020	LRP/45 M6x15	45	53	16	10,5	33,5	29	18	12	7,5	15	M6	19
7343025	LRP/45 M6x20	45	53	16	10,5	33,5	29	18	12	7,5	20	M6	20
7343040	LRP/65 M6x20	65	75	20	13,5	41	34	19	15	7,5	20	M6	30
7343045	LRP/65 M6x30	65	75	20	13,5	41	34	19	15	7,5	30	M6	31
7343050	LRP/65 M6x40	65	75	20	13,5	41	34	19	15	7,5	40	M6	33
7343060	LRP/65 M8x15	65	75	20	13,5	41	34	19	15	7,5	15	M8	33
7343065	LRP/65 M8x20	65	75	20	13,5	41	34	19	15	7,5	20	M8	35
7343070	LRP/65 M8x25	65	75	20	13,5	41	34	19	15	7,5	25	M8	37
7343075	LRP/65 M8x30	65	75	20	13,5	41	34	19	15	7,5	30	M8	38
7343085	LRP/65 M8x40	65	75	20	13,5	41	34	19	15	7,5	40	M8	44
7343100	LRP/80 M8x30	80	92	24	16,5	53	44	26	20	12	30	M8	61
7343105	LRP/80 M8x40	80	92	24	16,5	53	44	26	20	12	40	M8	78
7343110	LRP/80 M8x50	80	92	24	16,5	53	44	26	20	12	50	M8	81
7343130	LRP/80 M10x20	80	92	24	16,5	53	44	26	20	12	20	M10	74
7343135	LRP/80 M10x25	80	92	24	16,5	53	44	26	20	12	25	M10	77
7343140	LRP/80 M10x30	80	92	24	16,5	53	44	26	20	12	30	M10	80
7343145	LRP/80 M10x40	80	92	24	16,5	53	44	26	20	12	40	M10	85
7343150	LRP/80 M10x50	80	92	24	16,5	53	44	26	20	12	50	M10	89
7343170	LRP/80 M12x30	80	92	24	16,5	53	44	26	20	12	30	M12	94
7343175	LRP/80 M12x40	80	92	24	16,5	53	44	26	20	12	40	M12	101
7343180	LRP/80 M12x50	80	92	24	16,5	53	44	26	20	12	50	M12	108
7343210	LRP/95 M12x40	95	108	27	19	61	50	30	21	13	40	M12	133
7343215	LRP/95 M12x50	95	108	27	19	61	50	30	21	13	50	M12	139
7343225	LRP/95 M12x70	95	108	27	19	61	50	30	21	13	70	M12	154
7343240	LRP/95 M14x40	95	108	27	19	61	50	30	21	13	40	M14	150
7343245	LRP/95 M14x50	95	108	27	19	61	50	30	21	13	50	M14	166
7343260	LRP/95 M16x30	95	108	27	19	61	50	30	21	13	30	M16	163
7343270	LRP/95 M16x50	95	108	27	19	61	50	30	21	13	50	M16	193
7343275	LRP/95 M16x60	95	108	27	19	61	50	30	21	13	60	M16	220

NOTE: Su richiesta è disponibile il pulsante nei colori: arancione RAL 2004, rosso RAL 3020, giallo RAL 1021, blu RAL 5015, verde RAL 6018 e grigio RAL 7035. Si forniscono, per quantità adeguate, in colori diversi e con inserti a misura.

On request, the button is available in orange RAL 2004, red RAL 3020, yellow RAL 1021, blue RAL 5015, green RAL 6018 and grey RAL 7035. For certain minimum quantities, custom colors and threaded metal studs available upon request.

A petición, el pulsador está disponible en los siguientes colores: naranja RAL 2004, rojo RAL 3020, amarillo RAL 1021, azul RAL 5015, verde RAL 6018 y gris RAL 7035. Por cantidad apropiada, disponible también en colores diferentes y con insertos de distintas medidas.

MAB

Maniglia a ripresa Adjustable clamping lever / Manija ajustable



Descrizione

Bussola in acciaio zincato e foro cieco filettato.
Zinc plated steel insert with tapped blind hole.
Inserto de acero galvanizado y agujero ciego roscado.

Materiale

Tecnopolimero nero rinforzato con fibre di vetro, finitura opaca.
Black thermoplastic, glass fiber reinforced, mat.
Termoplástico negro reforzado con fibra de vidrio, acabado mate.

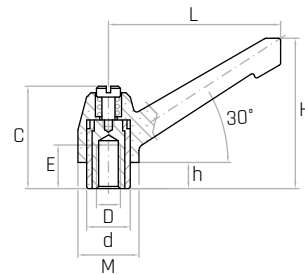

Codice	Modello	L mm	C mm	h mm	H mm	M mm	d mm	D	E mm	Peso gr.
7344015	MAB/40 M6	40	32	8	40	16	11	M6	13	19
7309015	MAB/55 M6	55	36	9	51	20	14	M6	14	26
7309020	MAB/55 M8	55	36	9	51	20	14	M8	14	24
7310005	MAB/79 M8	79	48	12	67	27	20	M8	20	56
7310010	MAB/79 M10	79	48	12	67	27	20	M10	20	55
7310015	MAB/79 M12	79	48	12	67	27	20	M12	20	57
7347005	MAB/100 M12	100	60	12	85	33	25	M12	25	113
7347010	MAB/100 M14	100	60	12	85	33	25	M14	25	124

NOTE: Si forniscono, per quantità adeguate, in colori diversi.
For certain minimum quantities, custom colors available upon request.
Por cantidad apropiada, disponible también en colores diferentes.

MAB/C

Maniglia fissa Clamping lever / Manilla fija



Descrizione

Bussola in acciaio zincato e foro cieco filettato.
Zinc plated steel insert with tapped blind hole.
Inserto de acero galvanizado y agujero ciego roscado.

Materiale

Tecnopolimero nero rinforzato con fibre di vetro, finitura opaca.
Black thermoplastic, glass fiber reinforced, mat.
Termoplástico negro reforzado con fibra de vidrio, acabado mate.

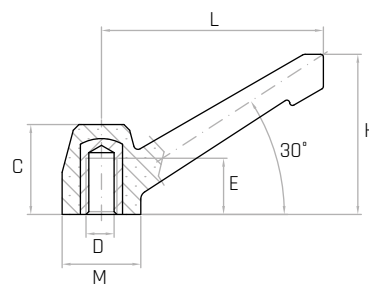

Codice	Modello	L mm	H mm	C mm	E mm	M mm	D	Peso gr.
7346015	MAB/40/C M6	40	31	20	9	16	M6	11
7311005	MAB/55/C M6	55	38	24	12	20	M6	17
7311010	MAB/55/C M8	55	38	24	12	20	M8	18
7310055	MAB/79/C M10	79	52	32	20	27	M10	42
7347100	MAB/100/C M12	100	74	43	20	33	M12	115

NOTE: Si forniscono, per quantità adeguate, in colori diversi.
For certain minimum quantities, custom colors available upon request.
Por cantidad apropiada, disponible también en colores diferentes.

Descrizione

Perno in acciaio zincato filettato.

Threaded zinc plated steel stud.

Perno de acero galvanizado roscado.



Materiale

Tecnopolimero nero rinforzato con fibre di vetro, finitura opaca.

Black thermoplastic, glass fiber reinforced, mat.

Termoplástico negro reforzado con fibra de vidrio, acabado mate.

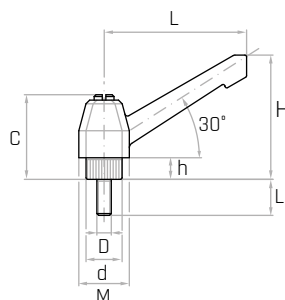

Codice	Modello	L mm	C mm	h mm	H mm	M mm	d mm	D	L1 mm	Peso gr.
7345012	MAP/40 M5x30	40	32	8	40	16	11	M5	30	20
7345015	MAP/40 M6x20	40	32	8	40	16	11	M6	20	20
7345017	MAP/40 M6x30	40	32	8	40	16	11	M6	30	24
7307015	MAP/55 M6x20	55	36	9	51	20	14	M6	20	30
7307014	MAP/55 M6x25	55	36	9	51	20	14	M6	25	30
7307016	MAP/55 M6x30	55	36	9	51	20	14	M6	30	31
7307017	MAP/55 M6x40	55	36	9	51	20	14	M6	40	33
7307018	MAP/55 M8x15	55	36	9	51	20	14	M8	15	33
7307020	MAP/55 M8x20	55	36	9	51	20	14	M8	20	35
7307021	MAP/55 M8x25	55	36	9	51	20	14	M8	25	37
7307022	MAP/55 M8x30	55	36	9	51	20	14	M8	30	38
7307026	MAP/55 M8x35	55	36	9	51	20	14	M8	35	41
7307023	MAP/55 M8x40	55	36	9	51	20	14	M8	40	44
7307024	MAP/55 M8x50	55	36	9	51	20	14	M8	50	45
7307025	MAP/55 M8x60	55	36	9	51	20	14	M8	60	49
7308005	MAP/79 M8x20	79	48	12	67	27	20	M8	20	72
7308007	MAP/79 M8x30	79	48	12	67	27	20	M8	30	74
7308008	MAP/79 M8x35	79	48	12	67	27	20	M8	35	76
7308009	MAP/79 M8x40	79	48	12	67	27	20	M8	40	78
7308011	MAP/79 M8x50	79	48	12	67	27	20	M8	50	81
7308010	MAP/79 M10x20	79	48	12	67	27	20	M10	20	74
7308025	MAP/79 M10x25	79	48	12	67	27	20	M10	25	77
7308012	MAP/79 M10x30	79	48	12	67	27	20	M10	30	80
7308014	MAP/79 M10x40	79	48	12	67	27	20	M10	40	85
7308017	MAP/79 M10x50	79	48	12	67	27	20	M10	50	89
7308018	MAP/79 M10x60	79	48	12	67	27	20	M10	60	94
7308015	MAP/79 M12x20	79	48	12	67	27	20	M12	20	88
7308019	MAP/79 M12x30	79	48	12	67	27	20	M12	30	94
7308020	MAP/79 M12x40	79	48	12	67	27	20	M12	40	101
7308021	MAP/79 M12x50	79	48	12	67	27	20	M12	50	108
7308022	MAP/79 M12x60	79	48	12	67	27	20	M12	60	114
7308004	MAP/79 M12x70	79	48	12	67	27	20	M12	70	120
7348005	MAP/100 M12x30	100	60	12	85	33	25	M12	30	156
7348010	MAP/100 M12x40	100	60	12	85	33	25	M12	40	163
7348015	MAP/100 M12x50	100	60	12	85	33	25	M12	50	169
7348020	MAP/100 M12x60	100	60	12	85	33	25	M12	60	176
7348025	MAP/100 M12x70	100	60	12	85	33	25	M12	70	184
7348030	MAP/100 M14x30	100	60	12	85	33	25	M14	30	168
7348035	MAP/100 M14x40	100	60	12	85	33	25	M14	40	180
7348040	MAP/100 M14x50	100	60	12	85	33	25	M14	50	196
7348045	MAP/100 M14x60	100	60	12	85	33	25	M14	60	202
7348050	MAP/100 M14x70	100	60	12	85	33	25	M14	70	214
7348055	MAP/100 M16x30	100	60	12	85	33	25	M16	30	193
7348060	MAP/100 M16x40	100	60	12	85	33	25	M16	40	213
7348065	MAP/100 M16x50	100	60	12	85	33	25	M16	50	223
7348070	MAP/100 M16x60	100	60	12	85	33	25	M16	60	250
7348075	MAP/100 M16x70	100	60	12	85	33	25	M16	70	278

NOTE: Si forniscono, per quantità adeguate, in colori diversi.

For certain minimum quantities, custom colors available upon request.

Por cantidad apropiada, disponible también en colores diferentes.

GA/B

Maniglia a ripresa Adjustable clamping lever / Manija ajustable



Descrizione

Inserto filettato in acciaio brunito.
Threaded burnished steel insert.
Inserto de acero pavonado roscado.

Materiale

Leva in lega di zinco, verniciata nera.
Cast zinc control lever, black varnished.
Palanca de aleación de zinc, pintada negra.

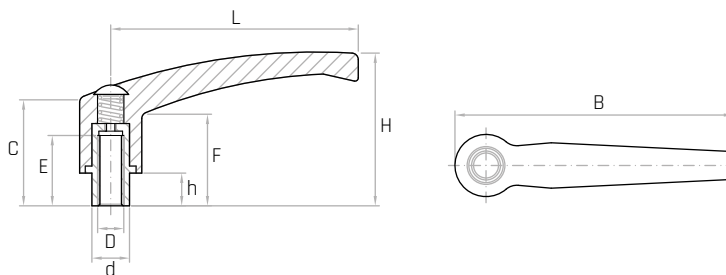

Codice	Modello	L mm	B mm	H mm	h mm	F mm	d mm	C mm	D	E mm	Peso gr.
7745005	GA44/B M4	44	52	36	5	21	9,5	23	M4	8	33
7745010	GA44/B M5	44	52	36	5	21	9,5	23	M5	8	35
7745015	GA44/B M6	44	52	36	5	21	9,5	23	M6	8	34
7745025	GA65/B M6	65	75	47	10	28	11,5	33	M6	11	72
7745030	GA65/B M8	65	75	47	10	28	11,5	33	M8	11	70
7745040	GA80/B M10	80	94	62	12	37	19	41	M10	18	167
7745045	GA80/B M12	80	94	62	12	37	19	41	M12	18	161
7745055	GA94/B M12	94	109	67	12	44	23	48	M12	24	315
7745060	GA94/B M14	94	109	67	12	44	23	48	M14	24	308
7745065	GA94/B M16	94	109	67	12	44	23	48	M16	24	298

NOTE: Si forniscono, per quantità adeguate, in colori diversi e con inserti a misura.

For certain minimum quantities, custom colors and tapped metal inserts available upon request.

Por cantidad apropiada, disponible también en colores diferentes y con insertos de distintas medidas.

Descrizione

Inserto filettato in acciaio brunito.

Threaded burnished steel insert.

Inserto de acero pavonado roscado.



Materiale

Leva in lega di zinco, verniciata nera.

Cast zinc control lever, black varnished.

Palanca de aleación de zinc, pintada negra.

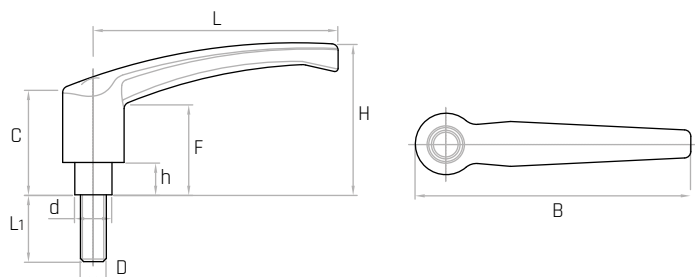

Codice	Modello	L mm	B mm	H mm	C mm	F mm	d mm	h mm	D	L1 mm	Peso gr.
7746010	GA44/P M4x25	44	52	36	23	21	9,5	5	M4	25	37
7746030	GA44/P M5x30	44	52	36	23	21	9,5	5	M5	30	40
7746050	GA44/P M6x20	44	52	36	23	21	9,5	5	M6	20	40
7746060	GA44/P M6x30	44	52	36	23	21	9,5	5	M6	30	42
7746100	GA44/P M8x20	44	52	36	23	21	9,5	5	M8	20	41
7746110	GA44/P M8x30	44	52	36	23	21	9,5	5	M8	30	43
7746130	GA65/P M6x20	65	75	47	33	28	11,5	10	M6	20	78
7746140	GA65/P M6x30	65	75	47	33	28	11,5	10	M6	30	80
7746180	GA65/P M8x20	65	75	47	33	28	11,5	10	M8	20	81
7746190	GA65/P M8x30	65	75	47	33	28	11,5	10	M8	30	84
7746200	GA65/P M8x40	65	75	47	33	28	11,5	10	M8	40	87
7746210	GA65/P M8x50	65	75	47	33	28	11,5	10	M8	50	90
7746250	GA65/P M10x30	65	75	47	33	28	11,5	10	M10	30	90
7746260	GA65/P M10x40	65	75	47	33	28	11,5	10	M10	40	95
7746300	GA80/P M10x20	80	94	62	41	37	19	12	M10	20	189
7746310	GA80/P M10x30	80	94	62	41	37	19	12	M10	30	195
7746320	GA80/P M10x40	80	94	62	41	37	19	12	M10	40	198
7746330	GA80/P M10x50	80	94	62	41	37	19	12	M10	50	204
7746340	GA80/P M10x60	80	94	62	41	37	19	12	M10	60	210
7746370	GA80/P M12x30	80	94	62	41	37	19	12	M12	30	201
7746380	GA80/P M12x40	80	94	62	41	37	19	12	M12	40	208
7746390	GA80/P M12x50	80	94	62	41	37	19	12	M12	50	215
7746400	GA80/P M12x60	80	94	62	41	37	19	12	M12	60	222
7746430	GA80/P M14x30	80	94	62	41	37	19	12	M14	30	210
7746440	GA80/P M14x40	80	94	62	41	37	19	12	M14	40	218
7746450	GA80/P M14x50	80	94	62	41	37	19	12	M14	50	228
7746460	GA80/P M14x60	80	94	62	41	37	19	12	M14	60	238
7746510	GA94/P M12x40	94	109	67	48	44	23	12	M12	40	362
7746520	GA94/P M12x50	94	109	67	48	44	23	12	M12	50	369
7746560	GA94/P M14x30	94	109	67	48	44	23	12	M14	30	366
7746570	GA94/P M14x40	94	109	67	48	44	23	12	M14	40	374
7746580	GA94/P M14x50	94	109	67	48	44	23	12	M14	50	382
7746590	GA94/P M14x60	94	109	67	48	44	23	12	M14	60	390
7746620	GA94/P M16x30	94	109	67	48	44	23	12	M16	30	376
7746630	GA94/P M16x40	94	109	67	48	44	23	12	M16	40	389
7746640	GA94/P M16x50	94	109	67	48	44	23	12	M16	50	402
7746650	GA94/P M16x60	94	109	67	48	44	23	12	M16	60	415

NOTE: Si forniscono, per quantità adeguate, in colori diversi e con inserti a misura.

For certain minimum quantities, custom colors and threaded metal studs available upon request.

Por cantidad apropiada, disponible también en colores diferentes y con insertos de distintas medidas.

NM/B

Maniglia a ripresa Adjustable clamping lever / Manija ajustable



Descrizione

Inserto filettato in acciaio brunito.

Threaded burnished steel insert.
Inserto de acero pavonado roscado.

Materiale

Leva in lega di zinco, verniciata nera.

Cast zinc control lever, black varnished.
Palanca de aleación de zinc, pintada negra.

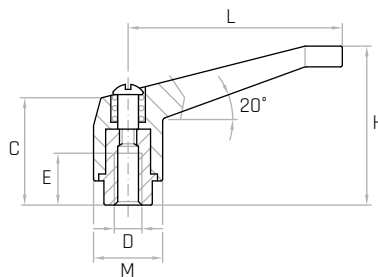

Codice	Modello	L mm	H mm	C mm	M mm	D	E mm	Peso gr.
7740005	NM40/B M4	40	29	24	16	M4	10	32
7740010	NM40/B M5	40	29	24	16	M5	10	32
7740015	NM40/B M6	40	29	24	16	M6	10	31
7740025	NM63/B M6	63	47	33	19	M6	13	65
7740030	NM63/B M8	63	47	33	19	M8	13	64
7740040	NM81/B M10	81	65	43	25	M10	19	166
7740045	NM81/B M12	81	65	43	25	M12	19	162
7740055	NM106/B M12	106	74	53	32	M12	24	316
7740065	NM106/B M14	106	74	53	32	M14	24	309
7740075	NM106/B M16	106	74	53	32	M16	24	299

NOTE: Si forniscono, per quantità adeguate, in colori diversi e con inserti a misura.

For certain minimum quantities, custom colors and tapped metal inserts available upon request.

Por cantidad apropiada, disponible también en colores diferentes y con insertos de distintas medidas.

NM/P

Maniglia a ripresa Adjustable clamping lever / Manija ajustable



Descrizione

Inserto filettato in acciaio brunito.

Threaded burnished steel insert.

Inserto de acero pavonado roscado.

Materiale

Leva in lega di zinco, verniciata nera.

Cast zinc control lever, black varnished.

Palanca de aleación de zinc, pintada negra.

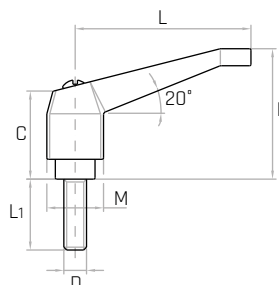

Codice	Modello	L mm	H mm	C mm	M mm	D	L1 mm	Peso gr.
7741005	NM40/P M5x20	40	29	24	16	M5	20	37
7741015	NM40/P M5x30	40	29	24	16	M5	30	38
7741025	NM40/P M6x20	40	29	24	16	M6	20	37
7741035	NM40/P M6x30	40	29	24	16	M6	30	39
7741045	NM63/P M6x20	63	47	33	19	M6	20	73
7741055	NM63/P M6x30	63	47	33	19	M6	30	75
7741065	NM63/P M8x20	63	47	33	19	M8	20	75
7741075	NM63/P M8x30	63	47	33	19	M8	30	79
7741085	NM63/P M8x40	63	47	33	19	M8	40	81
7741095	NM63/P M8x50	63	47	33	19	M8	50	85
7741105	NM81/P M10x20	81	65	43	25	M10	20	190
7741115	NM81/P M10x30	81	65	43	25	M10	30	196
7741125	NM81/P M10x40	81	65	43	25	M10	40	199
7741135	NM81/P M10x50	81	65	43	25	M10	50	205
7741145	NM81/P M10x60	81	65	43	25	M10	60	211
7741155	NM81/P M12x20	81	65	43	25	M12	20	194
7741165	NM81/P M12x30	81	65	43	25	M12	30	202
7741175	NM81/P M12x40	81	65	43	25	M12	40	209
7741185	NM81/P M12x50	81	65	43	25	M12	50	216
7741195	NM81/P M12x60	81	65	43	25	M12	60	223
7741205	NM106/P M14x30	106	74	53	32	M14	30	367
7741215	NM106/P M14x40	106	74	53	32	M14	40	377
7741225	NM106/P M14x50	106	74	53	32	M14	50	383
7741235	NM106/P M14x60	106	74	53	32	M14	60	396
7741245	NM106/P M16x30	106	74	53	32	M16	30	376
7741255	NM106/P M16x40	106	74	53	32	M16	40	390
7741265	NM106/P M16x50	106	74	53	32	M16	50	403
7741275	NM106/P M16x60	106	74	53	32	M16	60	416

NOTE: Si forniscono, per quantità adeguate, in colori diversi e con inserti a misura.

For certain minimum quantities, custom colors and threaded metal studs available upon request.

Por cantidad apropiada, disponible también en colores diferentes y con insertos de distintas medidas.

J/B

Maniglia a ripresa Adjustable clamping lever / Manija ajustable



Descrizione

Inserto filettato in acciaio brunito.

Threaded burnished steel insert.
Inserto de acero pavonado roscado.

Materiale

Leva in lega di zinco, verniciata nera.

Cast zinc control lever, black varnished.
Palanca de aleación de zinc, pintada negra.

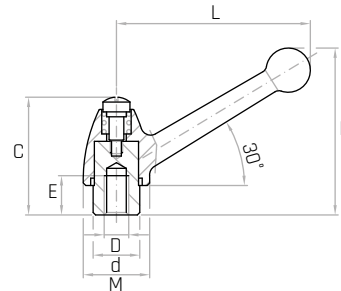

Codice	Modello	L mm	H mm	C mm	M mm	d mm	D	E mm	Peso gr.
7716005	J39/B M4	40	34	26	16	10	M4	9	24
7716010	J39/B M5	40	34	26	16	10	M5	9	23
7716020	J59/B M6	59	54	34	19	12	M6	13	59
7716025	J59/B M8	59	54	34	19	12	M8	13	57
7716035	J79/B M10	79	69	48	27	19	M10	17	152
7716040	J79/B M12	79	69	48	27	19	M12	17	146
7716050	J96/B M14	101	78	56	32	23	M14	23	244
7716055	J96/B M16	101	78	56	32	23	M16	23	235

NOTE: Si forniscono, per quantità adeguate, in colori diversi e con inserti a misura.

For certain minimum quantities, custom colors and tapped metal inserts available upon request.

Por cantidad apropiada, disponible también en colores diferentes y con insertos de distintas medidas.

Descrizione

Inserto filettato in acciaio brunito.
Threaded burnished steel insert.
Inserto de acero pavonado roscado.

Materiale

Leva in lega di zinco, verniciata nera.
Cast zinc control lever, black varnished.
Palanca de aleación de zinc, pintada negra.

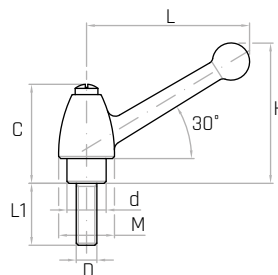

Codice	Modello	L mm	H mm	C mm	d mm	M mm	D	L1 mm	Peso gr.
7717005	J39/P M4x20	40	34	26	10	16	M4	20	26
7717015	J39/P M5x20	40	34	26	10	16	M5	20	28
7717025	J39/P M5x30	40	34	26	10	16	M5	30	29
7717040	J59/P M6x20	59	54	34	12	19	M6	20	65
7717045	J59/P M6x25	59	54	34	12	19	M6	25	66
7717050	J59/P M6x30	59	54	34	12	19	M6	30	67
7717060	J59/P M6x40	59	54	34	12	19	M6	40	68
7717070	J59/P M6x50	59	54	34	12	19	M6	50	70
7717085	J59/P M8x20	59	54	34	12	19	M8	20	68
7717090	J59/P M8x25	59	54	34	12	19	M8	25	69
7717095	J59/P M8x30	59	54	34	12	19	M8	30	71
7717105	J59/P M8x40	59	54	34	12	19	M8	40	74
7717115	J59/P M8x50	59	54	34	12	19	M8	50	78
7717125	J79/P M10x20	79	69	48	19	27	M10	20	174
7717135	J79/P M10x30	79	69	48	19	27	M10	30	180
7717145	J79/P M10x40	79	69	48	19	27	M10	40	183
7717155	J79/P M10x50	79	69	48	19	27	M10	50	189
7717165	J79/P M10x60	79	69	48	19	27	M10	60	194
7717175	J79/P M12x20	79	69	48	19	27	M12	20	178
7717185	J79/P M12x30	79	69	48	19	27	M12	30	186
7717195	J79/P M12x40	79	69	48	19	27	M12	40	193
7717205	J79/P M12x50	79	69	48	19	27	M12	50	200
7717215	J79/P M12x60	79	69	48	19	27	M12	60	207
7717230	J96/P M14x30	101	78	56	23	32	M14	30	303
7717240	J96/P M14x40	101	78	56	23	32	M14	40	313
7717250	J96/P M14x50	101	78	56	23	32	M14	50	319
7717260	J96/P M14x60	101	78	56	23	32	M14	60	332
7717270	J96/P M16x30	101	78	56	23	32	M16	30	311
7717280	J96/P M16x40	101	78	56	23	32	M16	40	325
7717290	J96/P M16x50	101	78	56	23	32	M16	50	339
7717300	J96/P M16x60	101	78	56	23	32	M16	60	351
7717310	J96/P M16x80	101	78	56	23	32	M16	80	375

NOTE: Si forniscono, per quantità adeguate, in colori diversi e con inserti a misura.

For certain minimum quantities, custom colors and threaded metal studs available upon request.

Por cantidad apropiada, disponible también en colores diferentes y con insertos de distintas medidas.

WZ/B

Maniglia a ripresa Adjustable clamping lever / Manija ajustable



Descrizione

Inserto filettato in acciaio brunito.
Threaded burnished steel insert.
Inserto de acero pavonado roscado.

Materiale

Leva in lega di zinco, verniciata nera.
Cast zinc control lever, black varnished.
Palanca de aleación de zinc, pintada negra.

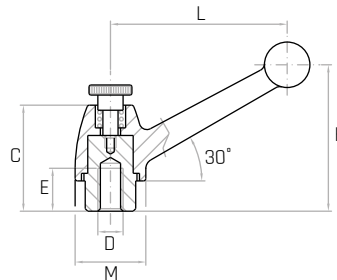

Codice	Modello	L mm	H mm	C mm	M mm	D	E mm	Peso gr.
7742005	WZ40/B M4	36	31	22	16	M4	9	25
7742010	WZ40/B M5	36	31	22	16	M5	9	24
7742015	WZ40/B M6	36	31	22	16	M6	9	23
7742030	WZ60/B M6	54	46	32	18	M6	13	63
7742035	WZ60/B M8	54	46	32	18	M8	13	61
7742050	WZ82/B M10	71	60	43	26	M10	17	161
7742055	WZ82/B M12	71	60	43	26	M12	17	155
7742070	WZ102/B M14	91	72	51	32	M14	23	253
7742075	WZ102/B M16	91	72	51	32	M16	23	344

NOTE: Si forniscono, per quantità adeguate, in colori diversi e con inserti a misura.

For certain minimum quantities, custom colors and tapped metal inserts available upon request.

Por cantidad apropiada, disponible también en colores diferentes y con insertos de distintas medidas.

WZ/P

Maniglia a ripresa Adjustable clamping lever / Manija ajustable



Descrizione

Inserto filettato in acciaio brunito.
Threaded burnished steel insert.
Inserto de acero pavonado roscado.

Materiale

Leva in lega di zinco, verniciata nera.
Cast zinc control lever, black varnished.
Palanca de aleación de zinc, pintada negra.

Codice	Modello	L mm	H mm	C mm	M mm	D	L1 mm	Peso gr.
7743015	WZ40/P M5x30	36	31	22	16	M5	30	30
7743045	WZ40/P M6x30	36	31	22	16	M6	30	30
7743060	WZ60/P M6x20	54	46	32	18	M6	20	39
7743070	WZ60/P M6x30	54	46	32	18	M6	30	71
7743090	WZ60/P M8x30	54	46	32	18	M8	30	75
7743100	WZ60/P M8x40	54	46	32	18	M8	40	78
7743110	WZ60/P M8x50	54	46	32	18	M8	50	82
7743135	WZ82/P M10x30	71	60	43	26	M10	30	189
7743145	WZ82/P M10x40	71	60	43	26	M10	40	192
7743155	WZ82/P M10x50	71	60	43	26	M10	50	198
7743165	WZ82/P M10x60	71	60	43	26	M10	60	203
7743175	WZ82/P M12x20	71	60	43	26	M12	20	187
7743185	WZ82/P M12x30	71	60	43	26	M12	30	195
7743195	WZ82/P M12x40	71	60	43	26	M12	40	202
7743205	WZ82/P M12x50	71	60	43	26	M12	50	209
7743215	WZ82/P M12x60	71	60	43	26	M12	60	216
7743240	WZ102/P M14x40	91	72	51	32	M14	40	322
7743250	WZ102/P M14x50	91	72	51	32	M14	50	328
7743280	WZ102/P M16x40	91	72	51	32	M16	40	334
7743290	WZ102/P M16x50	91	72	51	32	M16	50	348

NOTE: Si forniscono, per quantità adeguate, in colori diversi e con inserti a misura.

For certain minimum quantities, custom colors and tapped metal inserts available upon request.

Por cantidad apropiada, disponible también en colores diferentes y con insertos de distintas medidas.

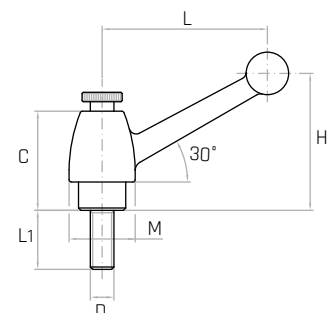

NTC/B

Maniglia fissa Clamping lever / Manilla fija



Descrizione

Pomolo a sfera in duroplasto nero.
Black phenolic plastic ball knob.
Pomo esférico de duroplástico negro.

Materiale

Maniglia in acciaio nero brunito.
Black burnished steel clamping lever.
Empuñadura de acero negro pavonado.

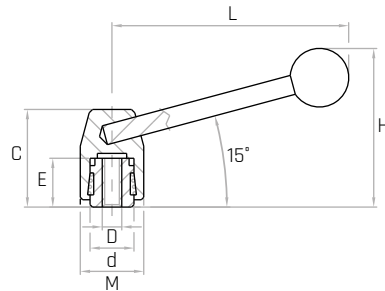

Codice	Modello	L mm	H mm	C mm	M mm	d mm	D	E mm	Peso gr.
7720020	NTC80/B M6	84	53	32	22	14	M6	19	91
7720025	NTC80/B M8	84	53	32	22	14	M8	19	104
7720035	NTC100/B M10	103	62	38	26	18	M10	21	157
7720040	NTC100/B M12	103	62	38	26	18	M12	21	150
7720050	NTC120/B M14	114	75	45	32	22	M14	24	270
7720055	NTC120/B M16	114	75	45	32	22	M16	24	260
7720065	NTC140/B M16	148	88	54	38	28	M16	30	461
7720070	NTC140/B M18	148	88	54	38	28	M18	30	451
7720071	NTC140/B M20	148	88	54	38	28	M20	30	450

NOTE: Si forniscono, per quantità adeguate, con inserto a misura.
For certain minimum quantities, tapped metal inserts available upon request.
Por cantidad apropiada, disponible también en colores diferentes.

E

Maniglia fissa Clamping lever / Manilla fija



Descrizione

Pomolo a sfera in duroplasto nero.
Black phenolic plastic ball knob.
Pomo esférico de duroplástico negro.

Materiale

Maniglia in zama nera, finitura opaca.
Black mat cast zinc clamping lever.
Empuñadura de zamak negra, acabado mate.

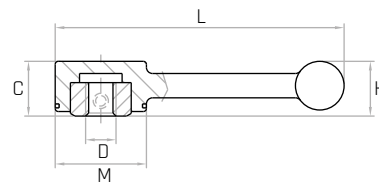

Codice	Modello	L mm	H mm	C mm	M mm	D	Peso gr.
7744005	E89 M8	89	21	17	28	M8	100
7744010	E89 M10	89	21	17	28	M10	90
7744020	E113 M10	113	28	23	34	M10	170
7744025	E113 M12	113	28	23	34	M12	176
7744030	E113 M14	113	28	23	34	M14	166



Gamm Srl

Via della Tecnica 21/23

35075 - Montecchio Maggiore (VI) - Italy

Tel. +39 0444 706311

comm@gamm.com

www.gamm.com

